

Junction Boxes Series 8118

STAHL

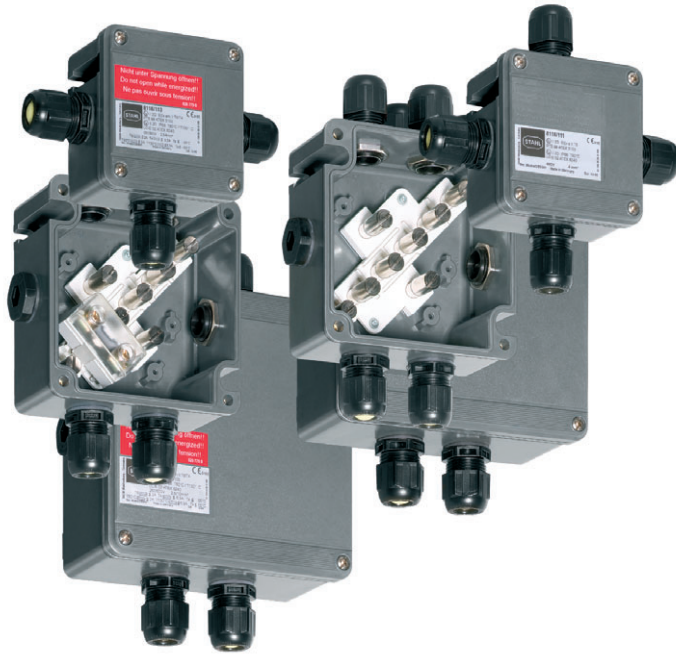

- > Enclosure made of glass fibre reinforced polyester resin
- > 3 different sizes available
 - with 4, 5 or 8 terminals
 - as a junction box with integrated miniature fuse:
 - 3 terminals and 1 miniature fuse
 - 7 terminals and 1 miniature fuse
 - 6 terminals and 2 miniature fuses
- > Degree of protection IP66

E3

www.stahl.de



02714E00



Series 8118 junction boxes are used to transport and distribute electrical energy in areas subject to explosion hazards. Three different sizes of robust enclosures made of glass fibre reinforced polyester resin are available. They are equipped with mantle terminals or with mantle terminals and miniature fuses. The junction boxes are therefore not only suitable as simple connection or distribution boxes but also for protecting electrical loads up to 6.3 A. In the standard version, plastic cable glands are used. If required, metal cable glands which can be installed in the earthing system by means of brass plates or cable glands with strain relief are available.





















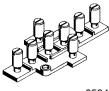

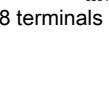
Zone	ATEX / IECEx					
	0	1	2	20	21	22
For use in		x	x		x	x

WebCode 8118A

Junction Boxes

Series 8118

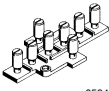
Selection Table

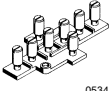





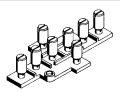

Version	Cable glands				Order number	Weight kg	
	Position	Holes	Cable glands	Stopping plug			
Ex e version size 1  01656E00	 05349E00 4 terminals	 09147E00 3 x M20 x 1.5	2 x M20 x 1.5	1 x M20 x 1.5	8118/111-401	0.280	
	 05576E00 5 terminals	 09148E00 4 x M20 x 1.5	3 x M20 x 1.5	1 x M20 x 1.5	8118/111-503	0.300	
	number of terminals according to the order		number of holes acc. to order	--	--	8118/111-.99	
	number of terminals according to the order		number of holes acc. to order	acc. to order	acc. to order	8118/211-.99	0.280
Ex i version size 1  01548E00	 05349E00 4 terminals	 09147E00 3 x M20 x 1.5	2 x M20 x 1.5	1 x M20 x 1.5	8118/211-401	0.280	
	 05576E00 4 terminals	 09148E00 4 x M20 x 1.5	3 x M20 x 1.5	1 x M20 x 1.5	8118/211-403	0.330	
	number of terminals according to the order		number of holes acc. to order	acc. to order	acc. to order	8118/211-.99	0.336
	number of terminals according to the order		number of holes acc. to order	acc. to order	acc. to order	8118/121-.99	0.570
Ex e version size 2  01655E00	 05348E00 8 terminals	 09149E00 4 x M25 x 1.5	3 x M25 x 1.5	1 x M25 x 1.5	8118/121-805	0.570	
	 05348E00 8 terminals	 09151E00 6 x M20 x 1.5	4 x M20 x 1.5	2 x M20 x 1.5	8118/121-806	0.560	
	 05348E00 8 terminals	 09151E00 6 x M25 x 1.5	4 x M25 x 1.5	2 x M25 x 1.5	8118/121-807	0.600	
	 05576E00 5 terminals	 09153E00 4 x M25 x 1.5	4 x M25 x 1.5	--	8118/121-538	0.625	
	 05576E00 5 terminals	 09150E00 2 x M25 x 1.5	2 x M25 x 1.5	--	8118/121-539	0.600	
	number of terminals according to the order		number of holes acc. to order	--	--	8118/121-.99	
	 05348E00 8 terminals	 09149E00 3 x M25 x 1.5	--*	3 x M25 x 1.5	8118/121-804-2	0.750	
Ex i version size 2  10549E00	 05348E00 8 terminals	number of holes acc. to order	acc. to order	acc. to order	8118/221-899	0.500	
	number of terminals according to the order		number of holes acc. to order	acc. to order	acc. to order	8118/221-899	0.500

Junction Boxes

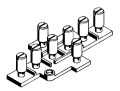
Series 8118

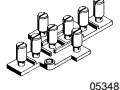

Selection Table

Version	Cable glands		Cable glands	Stopping plug	Order number	Weight kg	
	Position	Holes					
Ex e version size 3 	 8 terminals	 6 x M32 x 1.5	4 x M32 x 1.5	2 x M32 x 1.5	8118/131-811	0.850	
		 8 x M25 x 1.5	6 x M25 x 1.5	4 x M25 x 1.5			8118/131-814
	Number of terminals and fuses acc. to order		number of holes acc. to order	--	--	8118/131-.99	
	 8 terminals	 4 x M25 x 1.5	-*	4 x M25 x 1.5	8118/131-842-2	0.980	
Ex i version size 3 	 8 terminals	number of holes acc. to order	acc. to order	acc. to order	8118/231-899	0.612	
Ex e version size 1 	 3 terminals + 1 fuse	 4 x M20 x 1.5	2 x M20 x 1.5	2 x M20 x 1.5	8118/113-303	0.330	
Ex e version size 2 	Number of terminals and fuses acc. to order		number of holes acc. to order	--	8118/123-.99		
Note	Standard: cable glands, Series 8161 Option: metal cable glands with brass plate A non-standard arrangement is possible when using cable glands of the Series 8161 as well as when using cable glands with strain relief. Cable glands and stopping plugs are enclosed separately. The fuse must be ordered separately.						

E3

Junction Boxes





Series 8118

Explosion Protection

Global (IECEX)

Versions	junction box without miniature fuse			junction box with miniature fuse	
Type	8118/.11	8118/.21	8118/.31	8118/113	8118/123
Gas and dust	IECEX PTB 06.0026			IECEX PTB 06.0026	
	Ex e Ex e IIC T6 ... T4 Gb			Ex em II T *	
	Ex i Ex ia [ia Ga] ib IIA, IIB, IIC T6 ... T5 Gb			* depending on miniature fuse used	
	Ex tb IIC T80°C ... T130°C Db			Ex tD A21 IP66 T80°C, T95°C, T130°C	

Europe (ATEX)

Versions	junction box without miniature fuse			junction box with miniature fuse	
Type	8118/.11	8118/.21	8118/.31	8118/113	8118/123
Gas and dust	PTB 99 ATEX 3103			PTB 99 ATEX 3103	
	Ex e  II 2 G Ex e II T6, T5, T4			 II 2 G Ex em II T *	
	Ex i  II 2 G Ex ia/ib IIA, IIB, IIC T6, T5			* depending on miniature fuse used	
	 II 2 D Ex tD A21 IP66 T80°C, T95°C, T130°C			 II 2 D Ex tD A21 IP66 T80°C, T95°C, T130°C	

Certifications and certificates

Certificates	IECEX, ATEX, Brazil (INMETRO), China (China-Ex), India (PESO), Kazakhstan (GOST K), Korea (KCs), Russia (GOST R), Ukraine (TR)
--------------	--

Technical Data

Electrical data

Versions	junction box without miniature fuse			junction box with miniature fuse	
Type	8118/.11	8118/.21	8118/.31	8118/113	8118/123
Rated operational voltage	550 V	750 V	750 V	250 or 500 V , depending on miniature fuse used	
Connection Terminals					
Current carrying capacity at conductor cross-section of	max. 24 A 4 mm ²	max. 32 A 6 mm ²	max. 44 A 10 mm ²	max. 24 A 4 mm ²	max. 32 A 6 mm ²
Max. number of miniature fuses	--	--	--	1 x 8560	2 x 8560

Ambient conditions

Ambient temperature	Ex e: - 20 ... + 55 °C - 50 ... + 55 °C with special cable glands
	Ex i: - 20 ... + 75 °C - 50 ... + 75 °C with special cable glands

Mechanical data

Degree of protection	IP66
Material	
Enclosure	glass fibre reinforced polyester resin, dark grey similar to RAL 7012, impact resistance > 7 J, flame retardant acc. to IEC/EN 60695, UL 94, ASTM D635
Seal	Polyurethane, foamed
Cover lock	with captive M4 stainless steel combo head screws or

Junction Boxes

Series 8118



Technical Data

Mounting / Installation

Versions	junction box without miniature fuse			junction box with miniature fuse	
	8118/.11	8118/.21	8118/.31	8118/113	8118/123
Type					
Cable gland					
Standard	Cable glands, series 8161 and stopping plugs, series 8290 are enclosed separately. 3 x M20 4 x M20			Cable glands, series 8161 and stopping plugs, series 8290 are enclosed separately. --	
Special version	Holes according to order. Metal cable glands with brass plates or cable entry glands are possible.			Holes according to order. Metal cable glands with brass plates or cable entry glands are possible.	
Connection Terminals					
Type of terminals	mantle terminals	mantle terminals	mantle terminals	mantle terminals	mantle terminals
Max. number	4 or 5	5 or 8	8	3 when using 1 miniature fuse	7 when using 1 miniature fuse, 6 when using 2 miniature fuses
Max. conductor cross-section	4 mm ² solid	6 mm ² solid	10 mm ² solid	4 mm ² solid	6 mm ² solid

E3

Accessories and Spare Parts

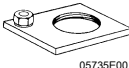
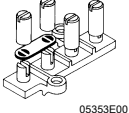
Designation	Figure	Description	Art. no.	Weight kg		
Brass plate with thread	 05735E00	for earth continuity when using metal glands; threads are cut acc. to order				
		for cable glands can be installed into enclosure				
			Size 1	Size 2	Size 3	
		1 x M20 x 1.5	Side C / D	Side C / D	Side C / D	133208 0.030
		1 x M25 x 1.5 1 x M32 x 1.5 2 x M20 x 1.5		Side C / D	Side C / D	133182 0.060
		2 x M25 x 1.5	Side C / D	Side C / D	133198 0.080	
		2 x M32 x 1.5		Side C / D	133202 0.140	
Cross connector	 05353E00		8118/.1.	133348 0.002		
			8118/.2.	133366 0.003		
			8118/.3.	133385 0.005		
		for bridging 2 side by side mantle terminals				

Junction Boxes

Series 8118

Accessories and Spare Parts

Designation	Figure	Description	Order number	Weight kg	
Fuse	 05736E00	8560/51, 250 V UC	Packaging units		
		I_N [A]	[pieces]		
		0.032	5	8560/51-4021	0.210
		0.05	5	8560/51-4031	0.210
		0.063	5	8560/51-4041	0.210
		0.08	5	8560/51-4051	0.210
		0.1	5	8560/51-4061	0.210
		0.125	5	8560/51-4071	0.210
		0.16	5	8560/51-4081	0.210
		0.2	5	8560/51-4091	0.210
		0.25	5	8560/51-4101	0.210
		0.315	5	8560/51-4111	0.210
		0.4	5	8560/51-4131	0.210
		0.5	5	8560/51-4141	0.210
		0.63	5	8560/51-4151	0.210
		0.8	5	8560/51-4171	0.210
		1.0	5	8560/51-4181	0.210
		1.25	5	8560/51-4191	0.210
		2.0	5	8560/51-4222	0.210
		4.0	5	8560/51-4252	0.210
		8560/61, 500 V UC		Packaging units	
		I_N [A]		[pieces]	
		0.08	5	8560/61-4051	0.210
		0.1	5	8560/61-4061	0.210
		0.125	5	8560/61-4071	0.210
		0.2	5	8560/61-4091	0.210
		0.25	5	8560/61-4101	0.210
		0.315	5	8560/61-4111	0.210
		0.4	5	8560/61-4131	0.210
		0.5	5	8560/61-4141	0.210

Junction Boxes

Series 8118



Dimensional Drawings (All Dimensions in mm) - Subject to Alterations

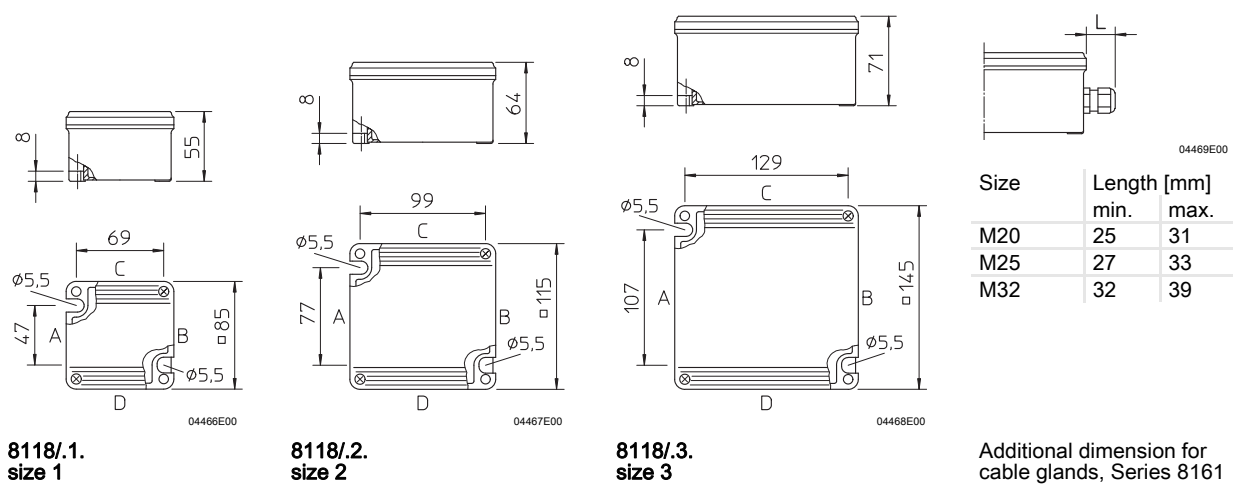

8118/1.
size 1

8118/2.
size 2

8118/3.
size 3

We reserve the right to make alterations to the technical data, dimensions, weights, designs and products available without notice. The illustrations cannot be considered binding.

E3